

清洗技术
Clean technology



国家高新技术企业 浙江省著名商标
www.cndonjoy.com



东正一直致力于重大技术进步，是您值得信赖的事业伙伴！
Donjoy committing to major technological advances, is your reliable business partner!

0.1	自控调节阀+控制器 Automatic control regulating valve +Control head
0.2	生物制药隔膜阀 Biopharmaceutical diaphragm valve
0.3	高洁净泵 High purity pumps
0.4	防混蝶阀+蝶阀 Mixing proof butterfly valve +Butterfly valve
0.5	球阀 Ball valve
0.6	截止换向阀+防混阀+罐底阀 Divert seat valve+Mixing proof valve +Tank bottom valve
0.7	角座阀+截止阀 Angle seat valve+Globe valve
0.8	止回阀+恒压阀+安全阀+减压阀 Check valve+constant pressure valve+safety valve +air release valve
0.9	清洁技术+取样阀+视镜+照明技术 Clean technology+sample valve+sight glass +lighting technology
0.10	过滤器+人孔 Filter+man hole cover(manway)
0.11	卫生管件 Sanitary fittings ASME BPE DIN11852 B94825 SMS ISO IDF 3A



注意：
目录技术资料仅供设计参考，
设计更新和技术升级恕不另行通知！

不断革新的技术、日新月异的市场发展和客户需求是当今我们面临的巨大挑战。面对这些挑战我们信心十足，因为东正高度专业化的产品和技术创新，是我们未来将以更高、更优的产品来满足不断增长的市场需求。

Technological innovation, rapid development of the market and customer needs are the greatest challenges facing us today. Facing with these challenges we are confident, because of highly professional products and technological innovation, we will meet the growing demand of market and customer with our better and better products.

法律声明：
目录样册版本属东正所有，如有抄袭东正将追究其法律责任和经济赔偿。
东正众多技术设计，都具有专利保护，如有抄袭，东正必将追究法律责任和经济赔偿。

领先源于创新 创新源于专业

东正的专业与品质的邂逅源于创新的精神



现代化工厂已经投产，期待您的光临！
温州空港经济园区生产基地
Wenzhou airport economic zone production base

占地面积29000m²，总投资1.2亿元，新引进ABB工业机器人、日本马扎克5轴加工中心、ABB机器人抛光设备。

Covering an area of 29000 m², with total investment after construction is expected to 120 million yuan, introduces new ABB industrial robot, Japan mazar-e-sharif grams of five axis machining center, ABB machine Polishing equipment.

东正创立于1993年，注册资金5508万，是一家专注于研发高品质PID过程控制器、阀门定位器、流量控制器，阀门控制单元，高洁净过程控制阀、智能自控阀，高洁净泵、高洁净管材和管道配件。公司高度专业化的产品和技术专注于生物制药、食品饮料、酿酒、精细化工等工业领域。东正众多的创新解决方案，对满足全球，尤其是新兴市场不断增长生物制药和食品饮料行业的需求起到了积极作用。

东正制造的产品母材料、加工技术、焊接技术、表面处理等技术指标均已达到国内外先进水平。且符合ASME BPE、EHEDG、FDA、3A等一系列国际标准和规范要求，先后通过了由德国TÜV机构实施的欧盟承压设备指令(PED-97/23/EC)和(MD-06/42/EC)认证、美国3A机构实施的3-A卫生标准认证、中国安全阀特种制造设备(TS)许可证和中国质量认证中心CQC ISO9001:2008质量管理体系认证等多项国际权威认证。

东正凭借先进的技术、优异的品质和完善的售后服务体系，先后被评定为国家高新技术企业，省著名商标、省科技型企业、创新型企业、专利示范企业、研发中心企业，守合同重信用AAA企业等众多荣誉。

关于东正 About DONJOY

Donjoy was built up in 1993, with registered capital RMB 55,08 millions. We focus on developing high quality PID process controller, the valve positioner, the flow controller, the valve control unit, high purity process control valve, intelligent self-control valve, high purity pump, high purity tubing fitting and pipeline accessories. Donjoy's products and technologies are widely used in biopharmaceutical, food, drink, wine fine chemicals and other industrial fields. Donjoy's innovation solutions meet the growing demand of the industry of biopharmaceutical, food and beverage from the whole world, especially the emerging market.

Raw material, processing technology, welding technology, surface treatment from Donjoy have achieved advanced levels of domestic and foreign market. Donjoy productions according to ASME BPE, EHEDG, FDA and 3A standard, get certificate of PED-97/23/EC and MD-06/42/EC issued by TUV, 3A issued by 3A organization, TS licence and ISO9001:2008.

Donjoy with advanced technology, excellent quality and perfect after-sales service system, has been assessed as the national high-tech enterprises, the Provincial Famous Trademark, the Provincial Science and Technology Enterprises, Innovative Enterprises, Patent Model Enterprises, R & D Center, AAA Credit Enterprises.



创立于2005年现代化工厂
温州滨海经济开发区生产基地
Wenzhou binhai economic development zone production base

DONJOY high-purity valve, pump, control system, pipe and accessories, provide the most excellent solution for various business scopes.



Biopharmaceutical



Dairy



Food



Beverage



Water Processing



Brewing



Fine Chemical

制造与检验 Manufacturing and testing



机器人生产线 Robot production line

全自动弯管设备 Automatic pipe bending equipment

DONJOY以科学技术是第一生产力，也是企业核心竞争力，只有不断投入核心技术研发和创新，不断追求卓越，精益求精、以先进生产设备，严格的质量管理体系，精密的生产检测流程，保证每一款产品优良的性能。

Science and technology constitute a primary productive force, also the core competitive strength of the enterprise. Continuously intensifying the research, development and innovation of core technology, pursuing prominence and keeping improving, ensuring the excellent quality and performance of every single product by advanced production equipment, strict quality control and precise production and inspection procedures.

荣誉与资质

Honor and qualification

	<p>3A</p> <p>东正是美国3A认证组织的金牌赞助商，3A是一个自愿组织，致力于维护公共卫生和奶制品产品质量通过独特的行业监管程序的设备，用于处理乳制品的卫生标准3A认证。 东正通过认证产品，阀门系列55-02-1783、64-00-1784、84-02-1786、85-03-1787、53-06-1782、54-02-1580、68-00-1785，管件(63-03)证书号(1581)等多种规格型号。</p>
	<p>PED/97/23/EC & MD/06/42EC</p> <p>东正通过了TUV 欧共体压力设备97/23/EC质量保证模式H&材料(管件)制造认证。 阀门证书 NO.CE 0036 泵类证书 NO.705201402401-00</p>
	<p>FDA177.2600</p> <p>东正生产的阀门和泵以及流体设备等，与物料接触密封圈全部通过或符合美国食品和药品管理局和联邦法规第21条即，CRF 21 FDA177.2600和FDA177.1550认证，其涵盖： EPDM VITON(FPM) SILICON HNBPTFE橡胶塑料材料等。</p>
	<p>ISO9001/2008</p> <p>东正通过中国质量认证中心CQC，ISO9001-2008/GB/T19001-2008企业质量管理体系认证。其证书编号: 00108Q24215R1M/3302</p>
	<p>卫生许可证</p> <p>东正通过了省卫生厅卫生阀门、卫生管件等检验，且获得了其颁发的证书，其编号: So083。 其许可证为国家出台的生活饮用水卫生监督管理方法证书。</p>
	<p>高新技术企业</p> <p>东正通过多年发展和技术创新已获得了多项国家发明专利，100多项实用新型专利，现已成为国家高新技术企业。</p>
	<p>浙江省著名商标</p> <p>东正09年获得了温州市著名商标，2012年获得了浙江省著名商标。</p>

DONJOY不但拥有以上认证和荣誉，且被评定为省科技型、创新型、专利示范、研发中心、守合同守信用企业等众多的荣誉证书。

新一代360°旋转喷射器 Rotary jet head(360°)

主要特点 Features

喷射器是一种先进的灌清洗机应用于:

- | | |
|---------|-------|
| ◆食品与乳制品 | 优势 |
| ◆制药 | ◆自清洗 |
| ◆化学处理 | ◆低液消耗 |
| ◆运输设备 | ◆卫生设计 |
| ◆饮料 | |

The injector is a kind of advanced irrigation cleaner used in:

- | | |
|------------------------------|-------------------------|
| ◆The food and dairy products | Advantage |
| ◆Pharmaceutical | ◆Self-cleaning |
| ◆Chemical treatment | ◆Low liquid consumption |
| ◆Transport equipment | ◆Hygienic design |
| ◆Beverage | |

工作原理 Operating principles

- ◆喷射器是卫生的水箱清洗机，提供360°覆盖范围在一个给定的罐或过程容器。喷射器是由流动的液体通过叶轮产生的动能。在压力和流量的增加会相应增加射流的长度和冲击力到罐或容器表面。
- ◆喷射器独特的自我清洗功能，内部被完全充分清洗。
- ◆Rotary injector is hygienic tank cleaner, with 360° coverage in a given tank or process container. The rotary jet head is driven by flow liquid through impeller. In the pressure and flow increase will increase the length of the jet and the impact to the tank or vessel surface.
- ◆Rotary injector with unique self cleaning function, internal is completely cleaning.

水箱清洗设备/安装方式 Tank cleaning equipment/Installation



典型应用 Typical application

- ◆ 固定安装CIP系统
- ◆ 过程容器和反应堆
- ◆ 储罐
- ◆ 运输灌设备
- ◆ 发酵
- ◆ 酵母繁殖
- ◆ Fixed installation CIP system
- ◆ Process containers and reactor
- ◆ Store tank
- ◆ Transport tank equipment
- ◆ Fermentation
- ◆ Yeast breeding

技术参数 Technical paramet

- ◆ 流量: 4-45m³
- ◆ 进口压力: 4-10bar
- ◆ 建议压力: 6bar
- ◆ 最高温度: 95°C
- ◆ 连接标准: 螺纹 BSP, 1.5"-DN40/1"DN25
- ◆ 卡箍DIN/INCH, 1.5"-DN40
- ◆ 材质: 316L/1.4404, 聚四氟乙烯
- ◆ 润滑: 清洗介质
- ◆ Flow: 4-45 m³
- ◆ inlet pressure: 4-10 bar
- ◆ Suggest pressure: 6 bar
- ◆ Max temperature: 95°C
- ◆ Connection: BSP, 1.5"- DN40/1"DN25
- ◆ Clamp DIN/INCH, 1.5"- DN40
- ◆ Material: 316L/1.4404, PTFE
- ◆ Lubrication: cleaning medium

性能曲线图 Performance curve

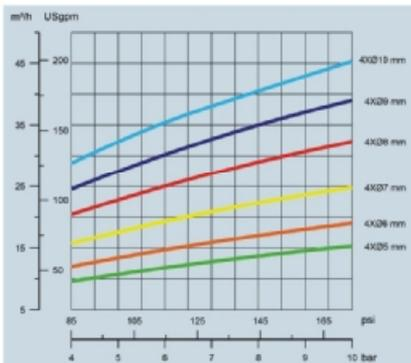

压力/流量曲线图
Pressure/flow Curve

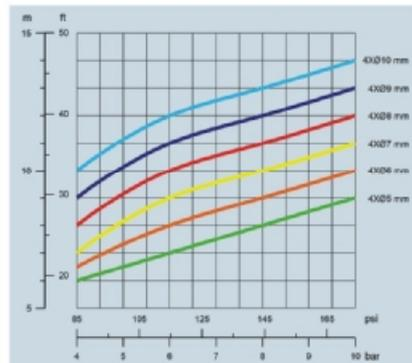

压力/射流长度曲线图
Pressure/jet length curve

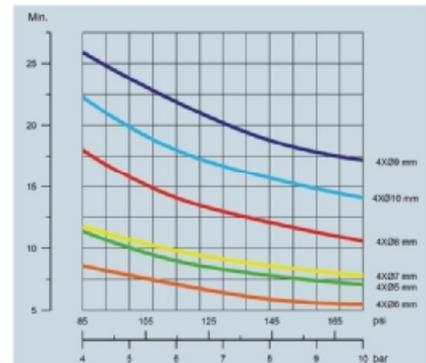

推荐清洗时间曲线图
Recommend cleaning time curve

规格参数 Specifications

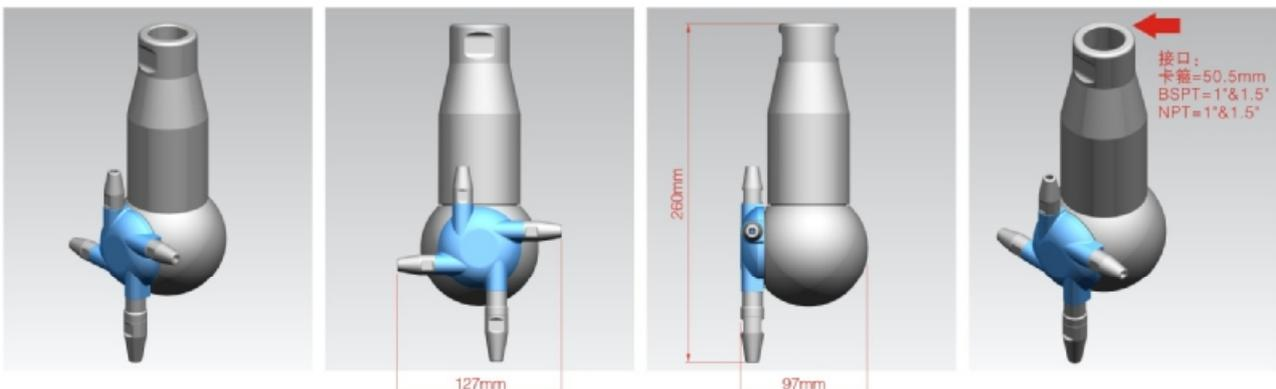

新一代360°旋转喷射器

Rotary jet head(360°)

软件模拟工具 Software simulation tool

以下图案是通过软件模拟实现，可以模拟在特定储罐或容器中的工作方式模拟过程将给出有关湿润强度、型网宽度和喷洗速度的信息。此信息用于确定储罐清洗机的最佳位置，以及要实施的流量、时间和压力的正确组合。演示包含各种不同的清洗模拟方案，涵盖了各种应用领域，可以用作储罐洗应用领域的参考和文献

The following pattern is achieved through software simulation. Can simulate a particular tank or vessel work simulation gives about cleaning intensity, Web width and spray type washing speed information. This information is used to determine the best position of tank cleaning machine, And the correct combination of traffic, time, and pressure to implement.

湿润强度

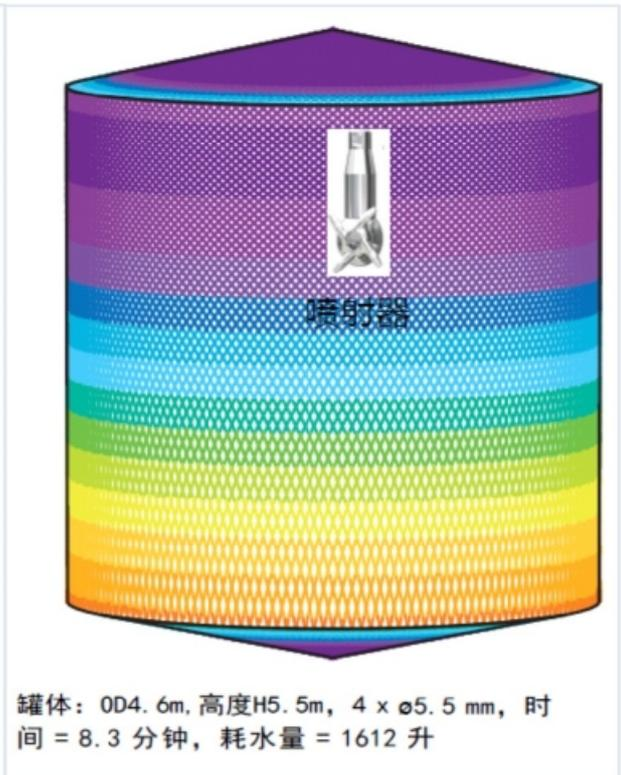
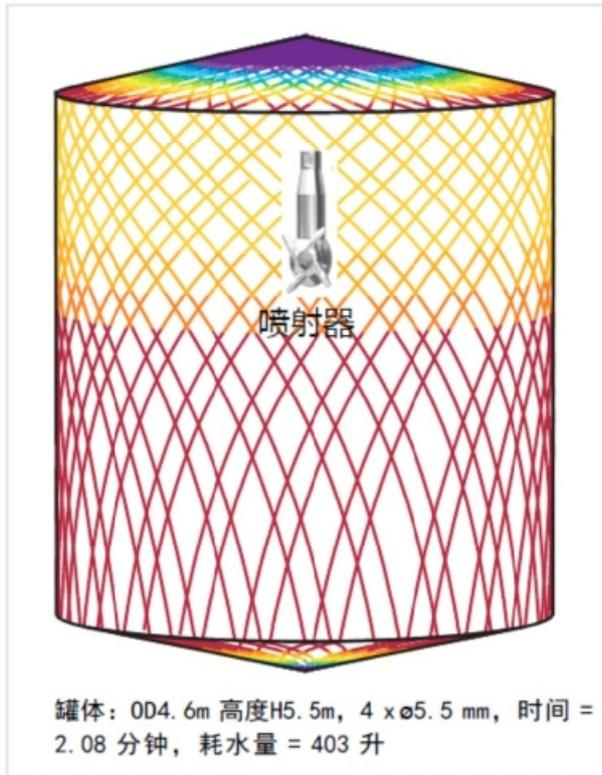
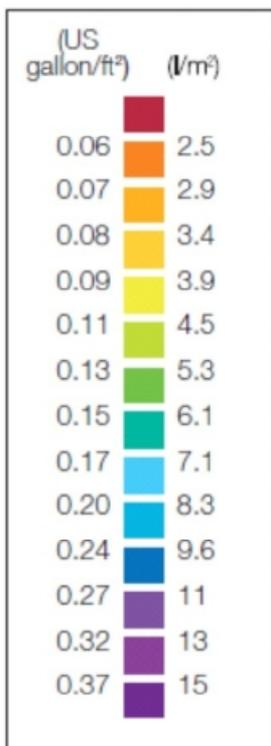

清洗器 Cleaner (spray ball)

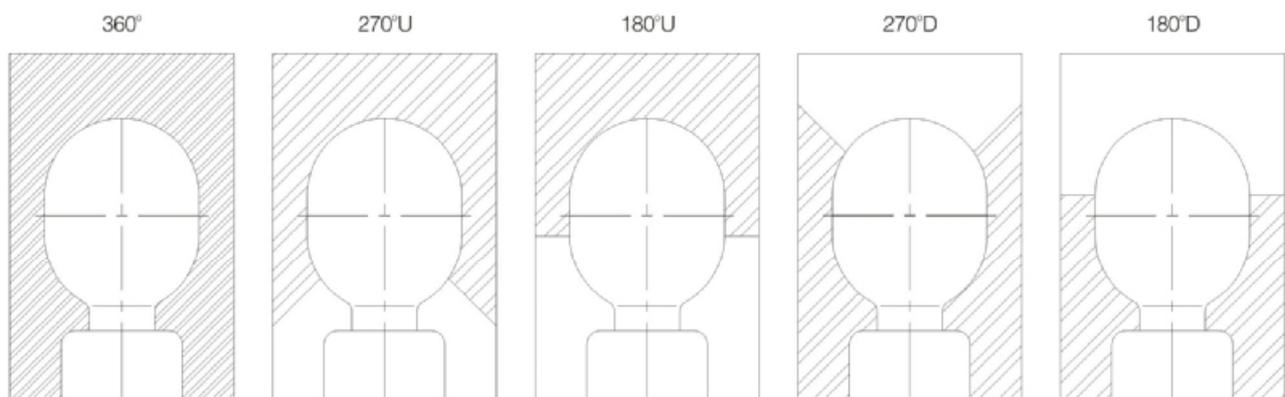

应用 Applications

- ◆清洗器系列产品主要应用在食品加工、饮料、啤酒制药工业领域等罐设备上，对罐内部进行强力的喷射和清洗。
- ◆固定清洗球：360度全部喷射、180度喷射、喷射孔径2.5mm
- ◆旋转清洗球：球状为椭圆形和圆形，喷射口为扁槽状型

- ◆Cleaner series products are mainly used to spray strongly and clean inside of tank, generally, in field of food-processing, beverage, beer, pharmaceutical industries.
- ◆Fixed cleaning Spray hole: 360 degree spray completely, 180 degree spray, aperture of spray is 2.5mm.
- ◆Rotary cleaning ball: ball is elliptical and spherical. Jet orifice is flat slot shape.

清洗球曲线图-Q28 Performance curve-Q28

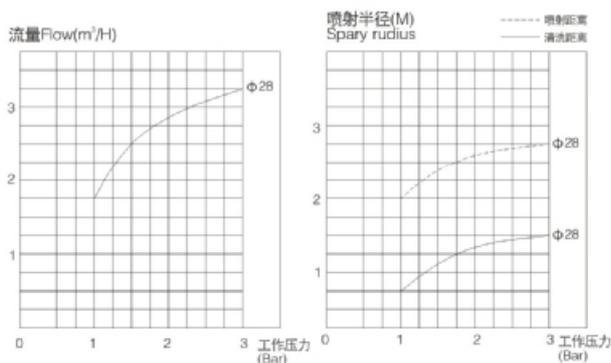

清洗球曲线图-Q45 Performance curve-Q45

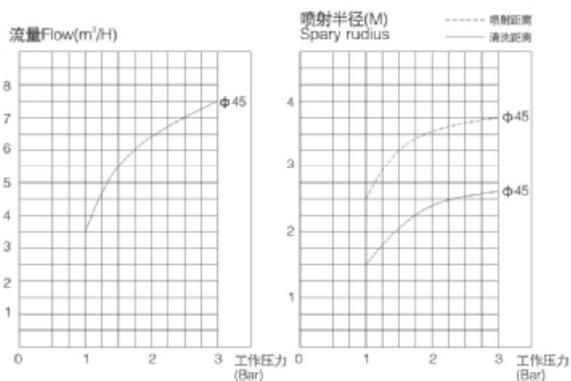

清洗球曲线图-Q65 Performance curve-Q65

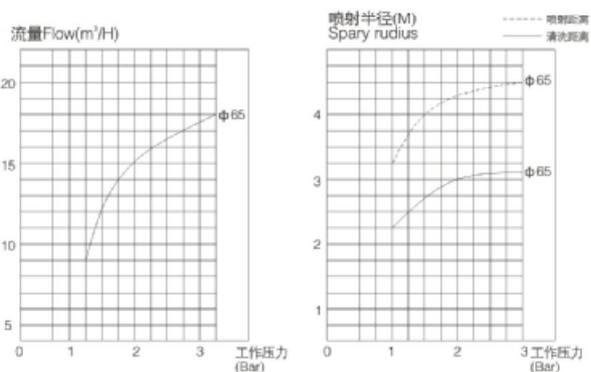

清洗球曲线图-Q75 Performance curve-Q75

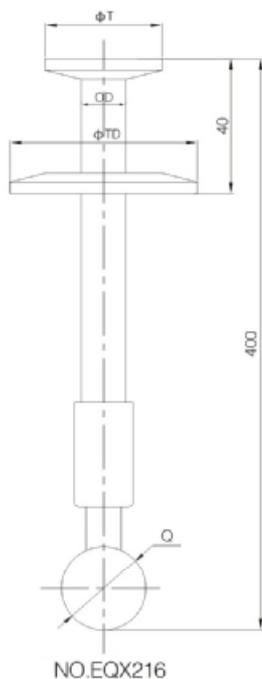
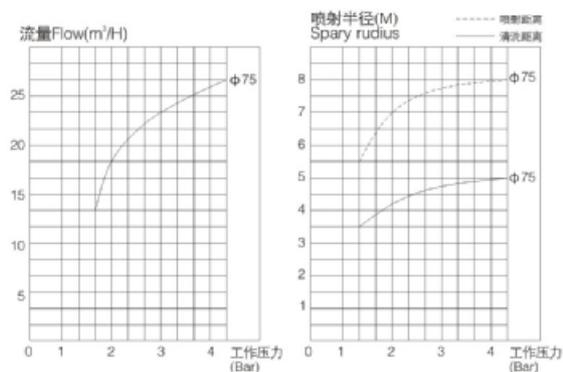

旋转清洗球(卡箍式)加长型
Rotary cleaning ball (clamped) Long type

Q	Size	OD	T	TD	2Bar压力		
					喷射半径(m) Spray radius	清洗半径(m) Cleaning radius	流量(m³/h) Flow rate
28	1/2"	12.7	25.4	77.5	2.5	1.1	2.5
45	1"	25.4	50.5	77.5	3.4	2.5	6.5
65	1.5"	38.1	50.5	91	4.2	3.1	15
75	2"	50.8	64	106	6.5	4.2	22

清洗器 Cleaner (spray ball)

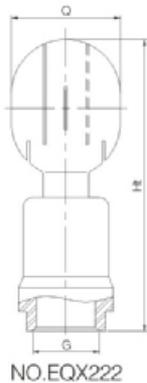

NO. EQX222

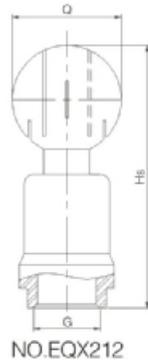

NO. EQX212

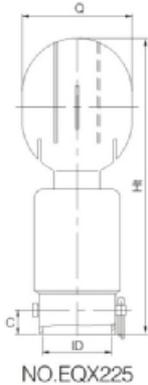

NO. EQX225

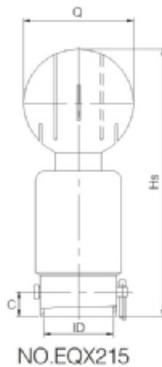

NO. EQX215

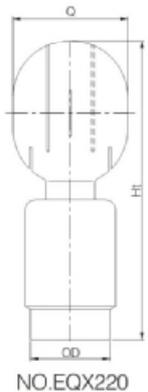

NO. EQX220

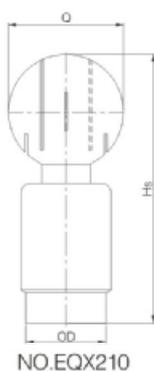

NO. EQX210

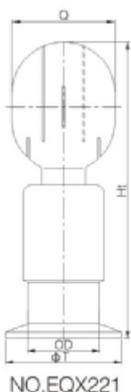

NO. EQX221

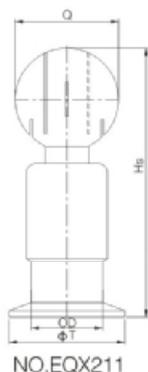

NO. EQX211

旋转清洗球(螺纹式) Rotary cleaning ball (threaded)

Q	G	Ht	Hs	2Bar压力		
				喷射半径(m) Spray radius	清洗半径(m) Cleaning radius	流量(m ³ /H) Flow rate
28	3/8"BSP	87.5	80.5	2.5	1.1	2.5
	1/2"BSP	90.5	83.5	2.8	1.2	2.8
	3/4"BSP	94.5	87.5	2.8	1.3	3.0
45	1/2"BSP	122.5	110.5	3.0	2.2	6
	3/4"BSP	126.5	114.5	3.4	2.5	6.5
	1"BSP	130.5	118.5	3.5	2.6	7.0
65	1"BSP	163.5	147.5	4.0	3.0	12
	1.25"BSP	165.5	149.5	4.2	3.1	15
	1.5"BSP	168.5	152.5	4.5	3.2	16
75	1.25"BSP	191.5	171.5	6.0	4.1	18
	1.5"BSP	194.5	174.5	6.5	4.2	22
	2"BSP	202.5	182.5	7.0	4.4	25

旋转清洗球(插销式) Rotary cleaning ball (Bolted)

Q	INCH		DIN		Ht	Hs	C	2Bar压力		
	Size	ID	Size	ID				喷射半径(m) Spray radius	清洗半径(m) Cleaning radius	流量(m ³ /H) Flow rate
28	1/2"	12.9	DN10	12.2	90.5	83.5	7	2.5	1.1	2.5
	3/4"	19.2	DN15	18.2	93.5	86.5	10	2.8	1.2	2.8
	1"	25.7	DN20	22.2	93.5	86.5	10	2.8	1.3	3.0
45	3/4"	19.2	DN20	22.2	128.5	116.5	10	3.0	2.2	6
	1"	25.7	DN25	28.3	128.5	116.5	10	3.4	2.5	6.5
	1.25"	32.1	DN32	34.3	128.5	116.5	10	3.5	2.6	7.0
65	1.25"	32.1	DN32	34.3	165.5	149.5	10	4.0	3.0	12
	1.5"	38.4	DN40	40.3	169.5	153.5	14	4.2	3.1	15
	2"	51.1	DN50	52.3	172.5	156.5	14	4.5	3.2	16
75	1.5"	38.4	DN40	40.3	197.5	177.5	14	6.0	4.1	18
	2"	51.1	DN50	52.3	197.5	177.5	14	6.5	4.2	22
	2.5"	63.8			201.5	181.5	14	7.0	4.4	25

旋转清洗球(焊接式) Rotary cleaning ball (welded)

Q	INCH		DIN		Ht	Hs	2Bar压力		
	Size	OD	Size	OD			喷射半径(m) Spray radius	清洗半径(m) Cleaning radius	流量(m ³ /H) Flow rate
28	1/2"	12.7	DN10	12	88.5	81.5	2.5	1.1	2.5
	3/4"	19	DN15	18	88.5	81.5	2.8	1.2	2.8
	1"	25.4	DN20	22	88.5	81.5	2.8	1.3	3.0
45	3/4"	19	DN20	22	124.5	112.5	3.0	2.2	6
	1"	25.4	DN25	28	124.5	112.5	3.4	2.5	6.5
	1.25"	31.8	DN32	34	124.5	112.5	3.5	2.6	7.0
65	1.25"	31.8	DN32	34	163	147	4.0	3.0	12
	1.5"	38.1	DN40	40	163	147	4.2	3.1	15
	2"	50.8	DN50	52	165	149	4.5	3.2	16
75	1.5"	38.1	DN40	40	192	172	6.0	4.1	18
	2"	50.8	DN50	52	192	172	6.5	4.2	22
	2.5"	63.5			193	173	7.0	4.4	25

旋转清洗球(卡箍式) Rotary cleaning ball (clamped)

Q	Size	OD	T	Ht	Hs	2Bar压力		
						喷射半径(m) Spray radius	清洗半径(m) Cleaning radius	流量(m ³ /H) Flow rate
28	1/2"	12.7	25.4	101.2	94.2	2.5	1.1	2.5
	3/4"	19	25.4	101.2	94.2	2.8	1.2	2.8
	1"	25.4	50.5	101.2	94.2	2.8	1.3	3.0
45	3/4"	19	25.4	137.2	125.2	3.0	2.2	6
	1"	25.4	50.5	137.2	125.2	3.4	2.5	6.5
	1.25"	31.8	50.5	137.2	125.2	3.5	2.6	7.0
65	1.25"	31.8	50.5	175.7	159.7	4.0	3.0	12
	1.5"	38.1	50.5	175.7	159.7	4.2	3.1	15
	2"	50.8	64	177.7	161.7	4.5	3.2	16
75	1.5"	38.1	50.5	204.7	184.7	6.0	4.1	18
	2"	50.8	64	204.7	184.7	6.5	4.2	22
	2.5"	63.5		205.7	185.7	7.0	4.4	25

固定式清洗球

Fixed cleaning ball

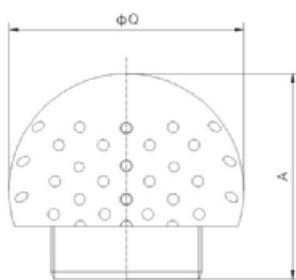

NO.EQX313

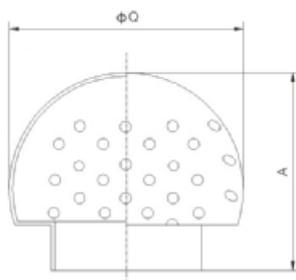

NO.EQX310

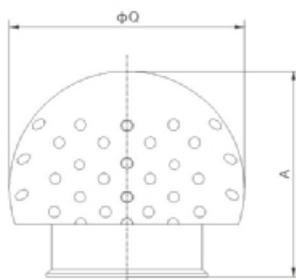

NO.EQX311

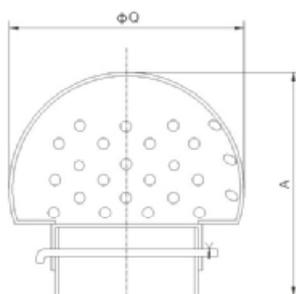

NO.EQX315

应用 Applications

- ◆固定清洗球:360度全部喷射、180度喷射、喷射孔径25mm。
- ◆Fixed cleaning ball:360 degree spray completely 180 degree spray aperlure of spray is 2.5mm.

螺纹式 Threaded

SIZE	Q	A	压力(bar) Pressure	喷射半径(m) Spray radius	流量(m ³ /h) Flow rate (360° /180°)
1"	63	72	2.5	1.0-1.25	17/10
1.25"	76	85	2.5	1.25-1.75	23/17
1.5"	76	85	2.5	1.25-1.75	23/17
2"	76	87	3.5	2.0-3.0	55/38
2.5"	91	102	3.5	3.0-3.5	58/41

焊接式 Welded

SIZE	Q	A	压力(bar) Pressure	喷射半径(m) Spray radius	流量(m ³ /h) Flow rate (360° /180°)
1"	53	72	2.5	1.0-1.25	17/10
1.5"	63	85	2.5	1.25-1.75	23/17
2"	91	87	3.5	2.0-3.0	55/38
2.5"	100	102	3.5	3.0-3.5	58/41

卡箍式 Clamped

SIZE	Q	A	压力(bar) Pressure	喷射半径(m) Spray radius	流量(m ³ /h) Flow rate (360° /180°)
1"	63	80	2.5	1.0-1.25	17/10
1.25"	76	93	2.5	1.25-1.75	23/17
1.5"	76	93	2.5	1.25-1.75	23/17
2"	91	108	3.5	2.0-3.0	55/38
2.5"	100	115	3.5	3.0-3.5	58/41

插销式 Bolted

SIZE	Q	A	压力(bar) Pressure	喷射半径(m) Spray radius	流量(m ³ /h) Flow rate (360° /180°)
1"	63	72	2.5	1.0-1.25	17/10
1.5"	76	85	2.5	1.25-1.75	23/17
2"	91	87	3.5	2.0-3.0	55/38
2.5"	100	102	3.5	3.0-3.5	58/41

气动截止阀+清洗球 Pneumatic globe valve + cleaning ball

技术特点

该清洗阀，主要解决了因清洗球长期泡在介质中形成的死角而容易细菌繁殖而污染介质。该阀门开启时清洗，关闭时保持清洗球与介质不接触，从而避免了死角。

Technical features

The flushing valve, mainly solved by cleaning ball long soak in the medium forming bacteria and dead easy contamination media. When the valve is opened to clean and maintain the cleaning medium is not in contact with the ball is closed, thus avoiding the dead angle.

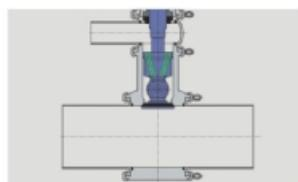

卡箍连接

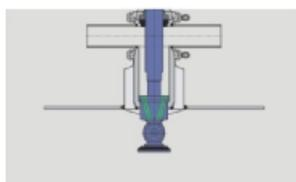

对焊连接

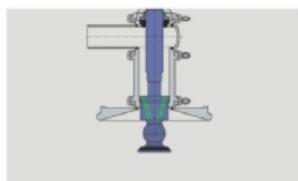

法兰连接

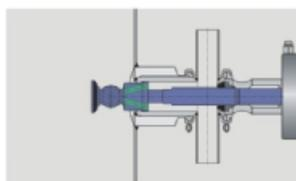

侧面焊接连接

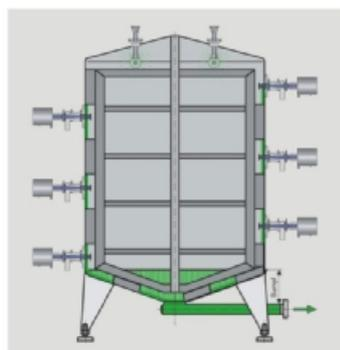

容器设备清洗示例

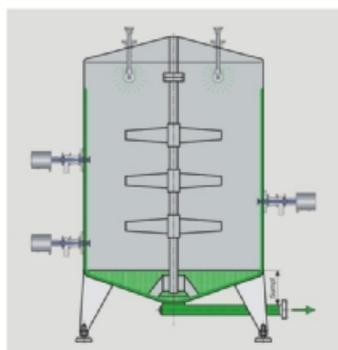

容器设备清洗示例

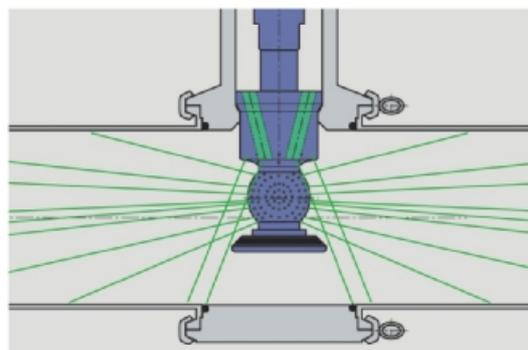

管道清洗示例

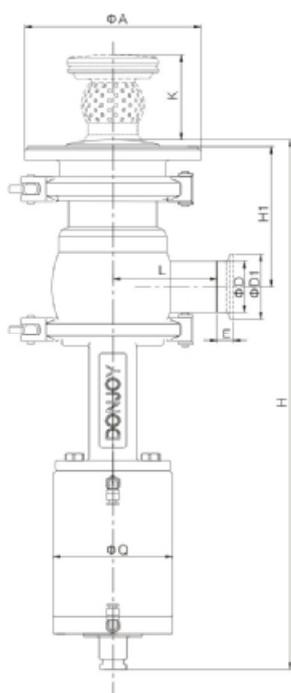

NO.VHX800Q1

DIN气动截止换向阀+清洗球
DIN Pneumatic Divert Seat Valve

SIZE	D	D1	Q	A	L	H1	H	K	E
DN25	28	50.5	88	130	70	98	433	53	12.7
DN40	41	50.5	88	130	80	104	443	53	12.7
DN50	52	64	113	150	80	111	476	53	12.7

INCH气动截止换向阀+清洗球
INCH Pneumatic Divert Seat Valve

SIZE	D	D1	Q	A	L	H1	H	K	E
1"	25.4	50.5	88	130	70	98	433	53	12.7
1.5"	38.1	50.5	88	130	80	104	443	53	12.7
2"	50.8	64	113	150	80	111	476	53	12.7

如您，需更大的规格请联系东正！
 Such as your need larger size, please contact the Theotokos!





CHINA DONJOY TECHNOLOGY CO.,LTD.

DONJOY looking forward to your visit! Your telecommunications!



中国·东正
科技有限公司

地址: 温州龙湾区空港新区港富路25号
总机: 0577-86990888
传真: 0577-86998000

Add : No.25 Gang fu Road,
kong gang new District,
Longwan Wenzhou,China
Tel: +86-577-86990888
Fax: +86-577-86998000
E-mail: donjoy@cndonjoy.com

www.cndonjoy.com

法律声明:

目录样册版本属东正所有, 如有抄袭东正将追究其法律责任和经济赔偿。
东正众多技术设计, 都具有专利保护, 如有抄袭, 东正必将追究法律责任和经济赔偿。